

ASSEMBLY INSTRUCTION

3294-2774









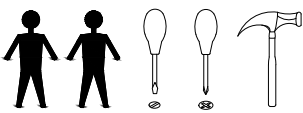



A	B	C	D	E	F
 $\varnothing 8 \times 20$	 M8x50	 M8x40	 P5	 $\varnothing 60 \times 25$	 $\varnothing 4.5 \times 30$
40 PCS	16 PCS	24 PCS	1 PC	6 PCS	4 PCS
G	H	I			
 $\varnothing 8 \times \varnothing 14$	 glue				
40 PCS	2 PCS	40 PCS			

FIG. 1

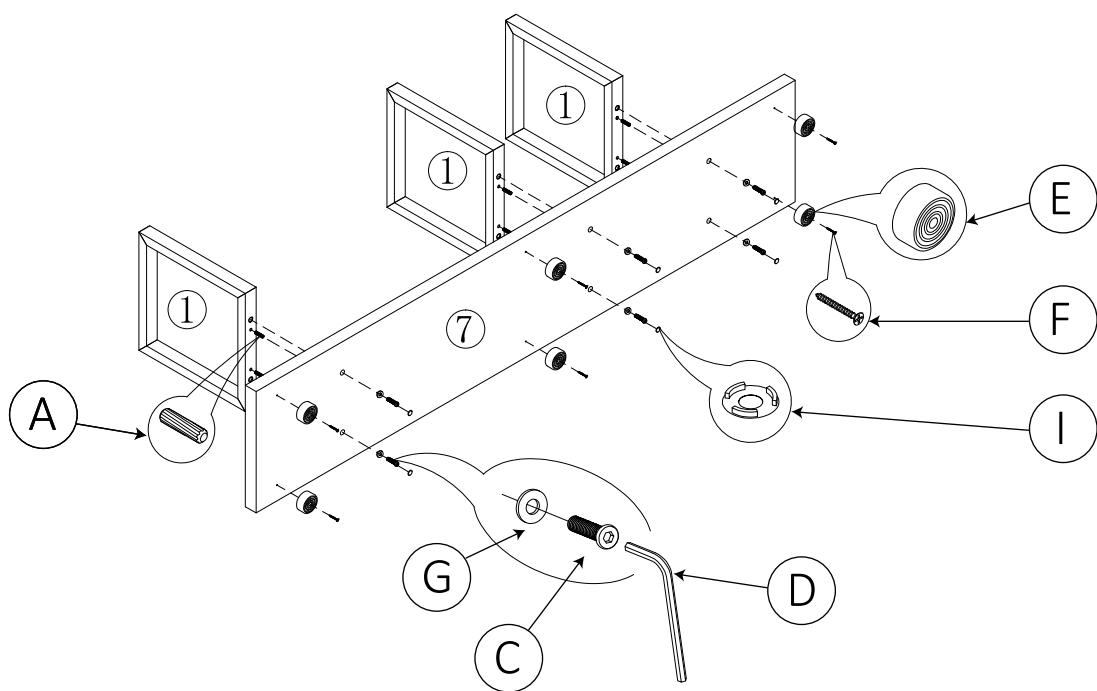
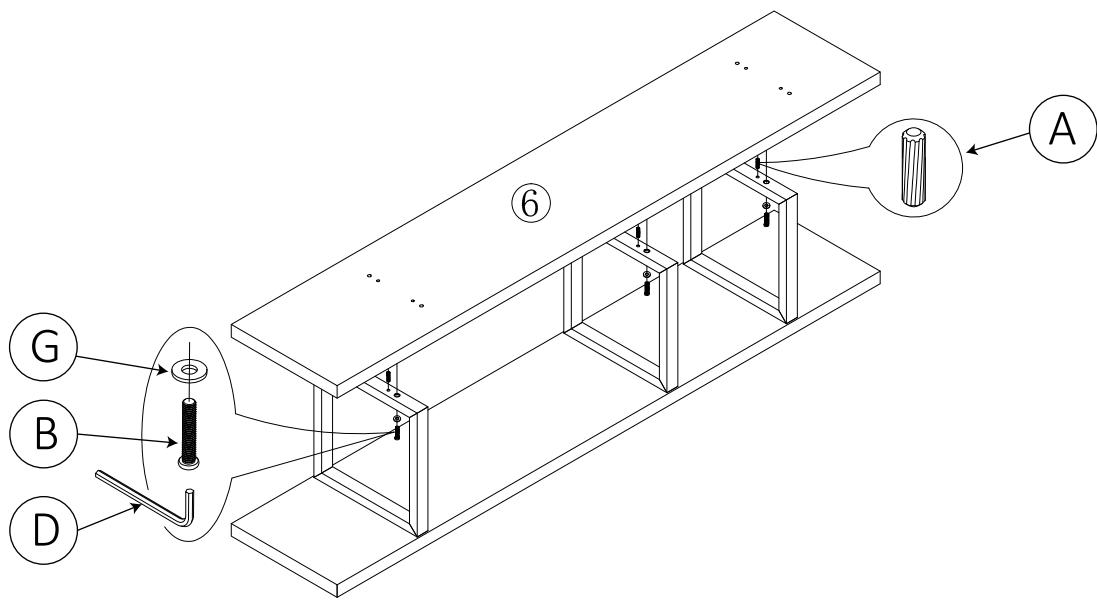






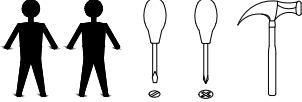
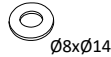


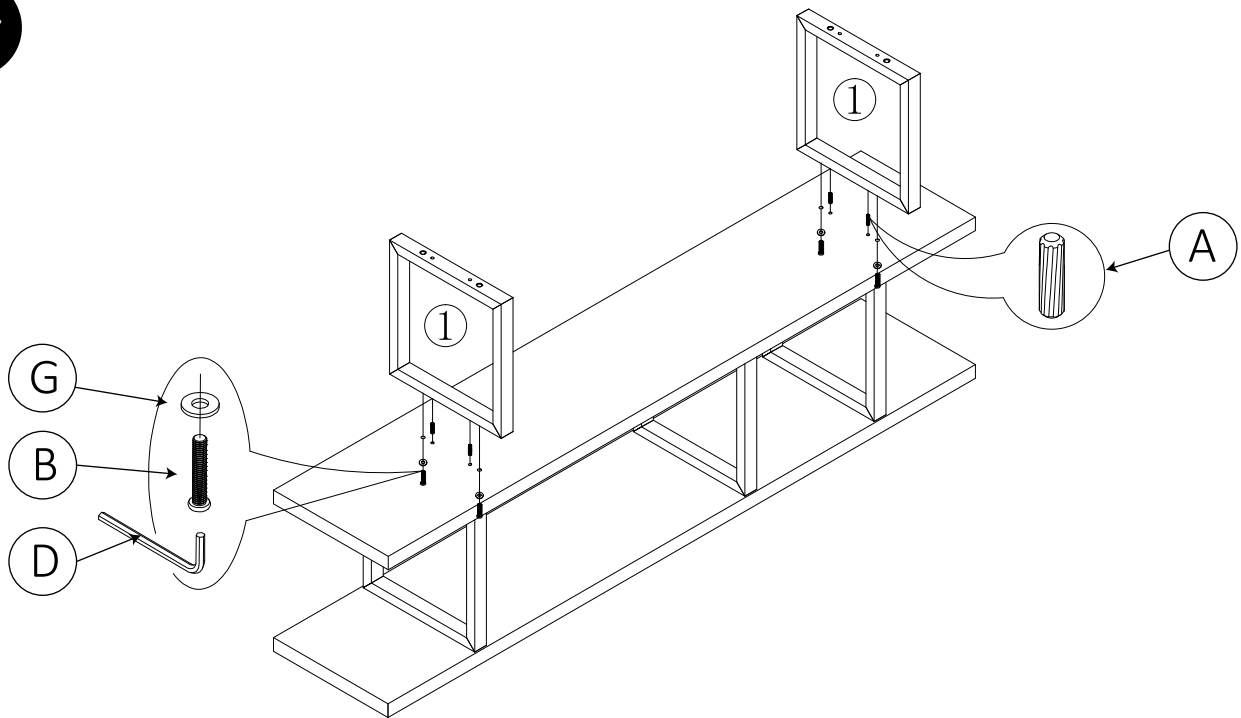


FIG. 2

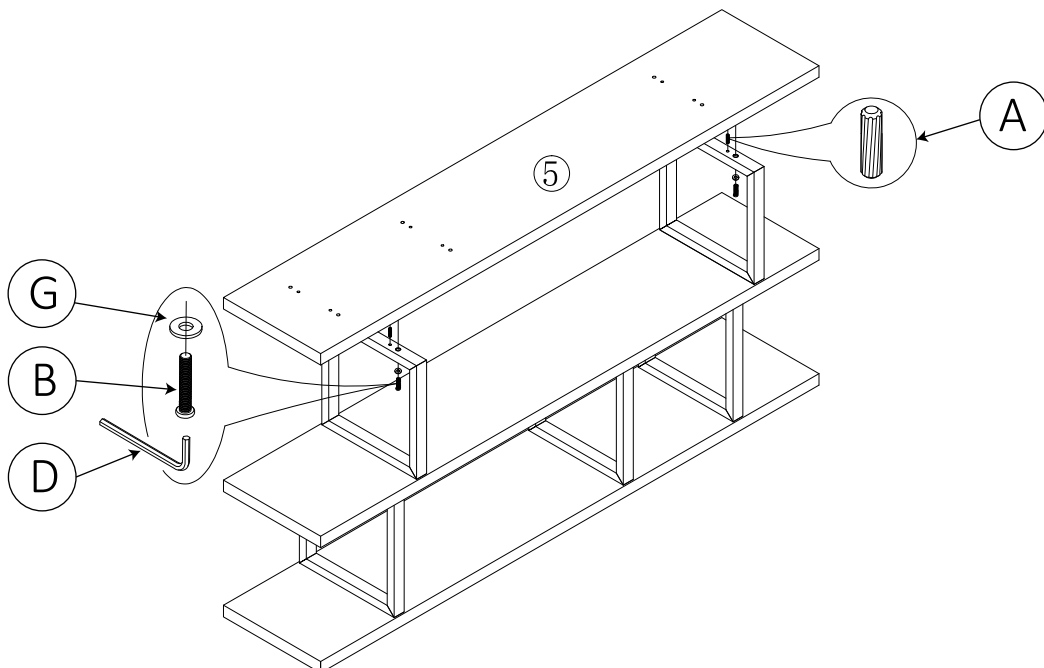


A	B	C	D	E	F
 $\varnothing 8 \times 20$	 M8x50	 M8x40	 P5	 $\varnothing 60 \times 25$	 $\varnothing 4.5 \times 30$
40 PCS	16 PCS	24 PCS	1 PC	6 PCS	4 PCS
G	H	I			
 $\varnothing 8 \times \varnothing 14$	 glue				
40 PCS	2 PCS	40 PCS			

**FIG.
3**



**FIG.
4**









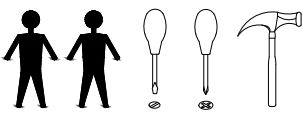
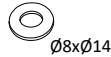


A	B	C	D	E	F
					
40 PCS	16 PCS	24 PCS	1 PC	6 PCS	4 PCS
G	H	I			
					
40 PCS	2 PCS	40 PCS			

FIG. 5

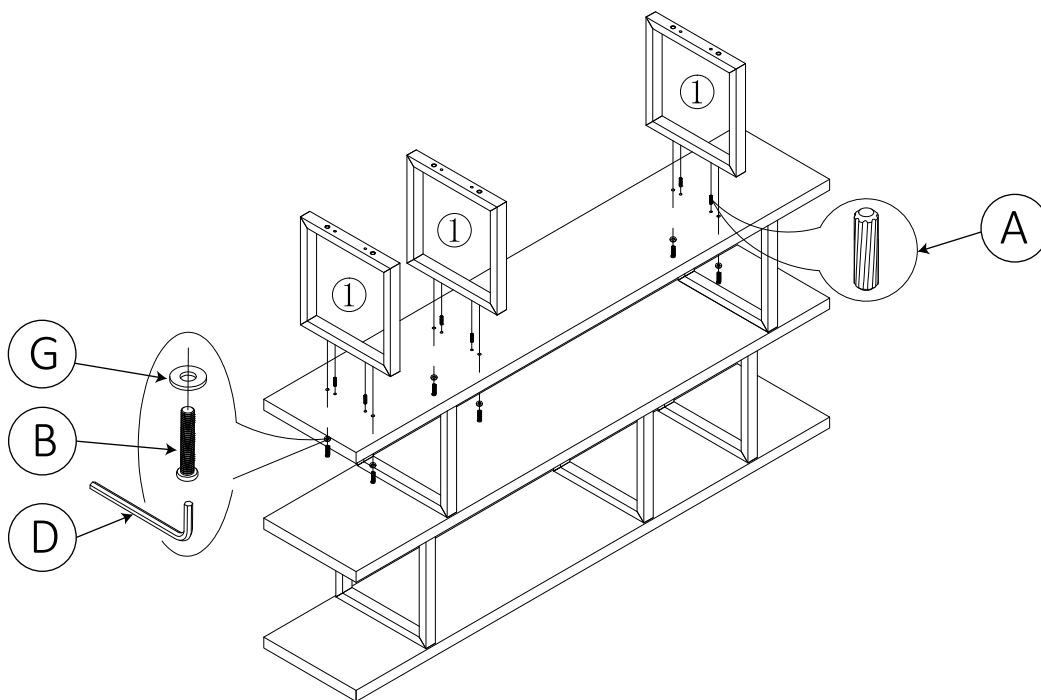
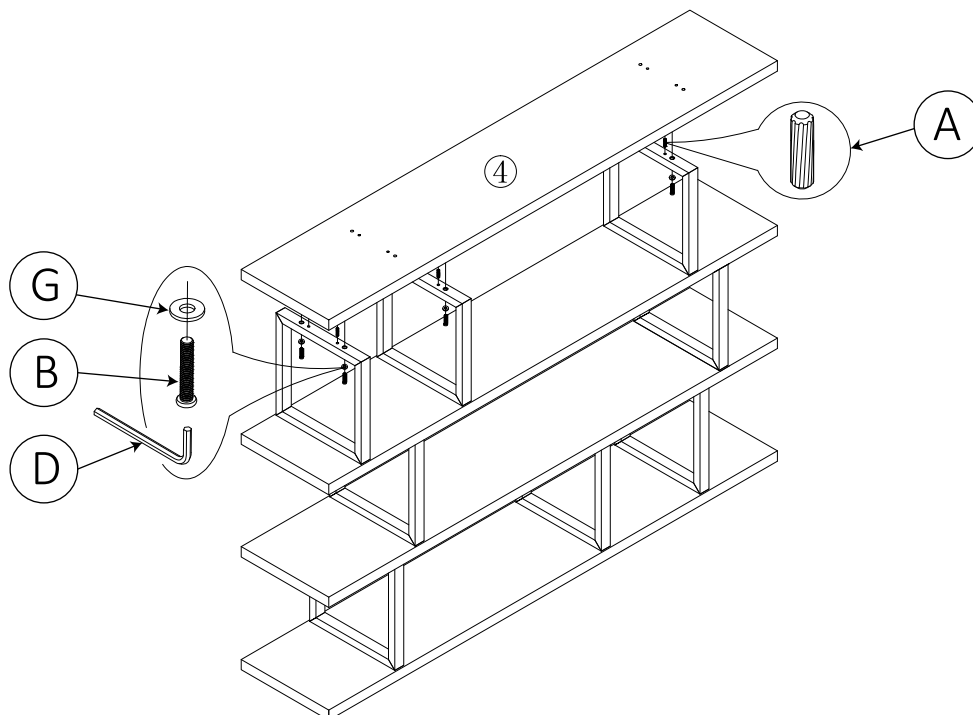


FIG. 6









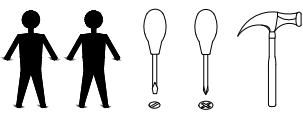



A	B	C	D	E	F
 Ø8x20	 M8x50	 M8x40	 P5	 Ø60x25	 Ø4.5x30
40 PCS	16 PCS	24 PCS	1 PC	6 PCS	4 PCS
G	H	I			
 Ø8xØ14	 glue				
40 PCS	2 PCS	40 PCS			

FIG.
7

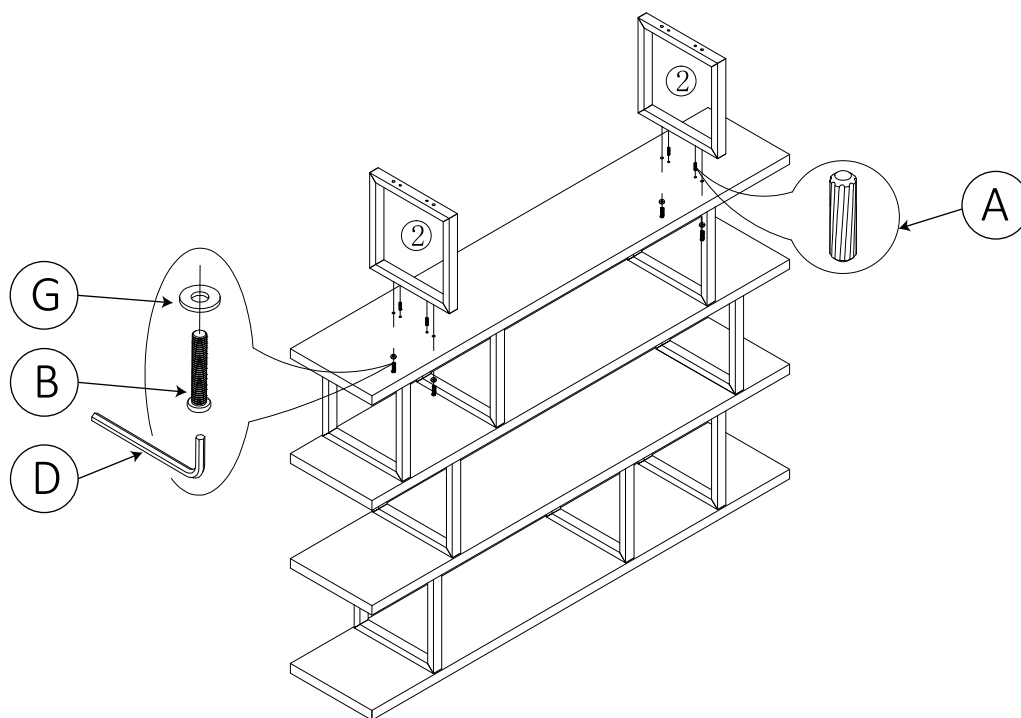


FIG.
8

