

ASSEMBLY INSTRUCTION

1190-2775



A	B	C	D	E	F	G
4 PCS	4 PCS	4 PCS	4 PCS	6 PCS	10 PCS	16 PCS
H	I	J	K	L	M	N
16 PCS	16 PCS	1 PC	2 PCS	10 PCS	4 PCS	1 PC

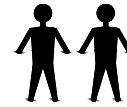
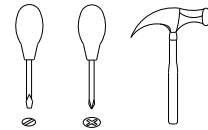
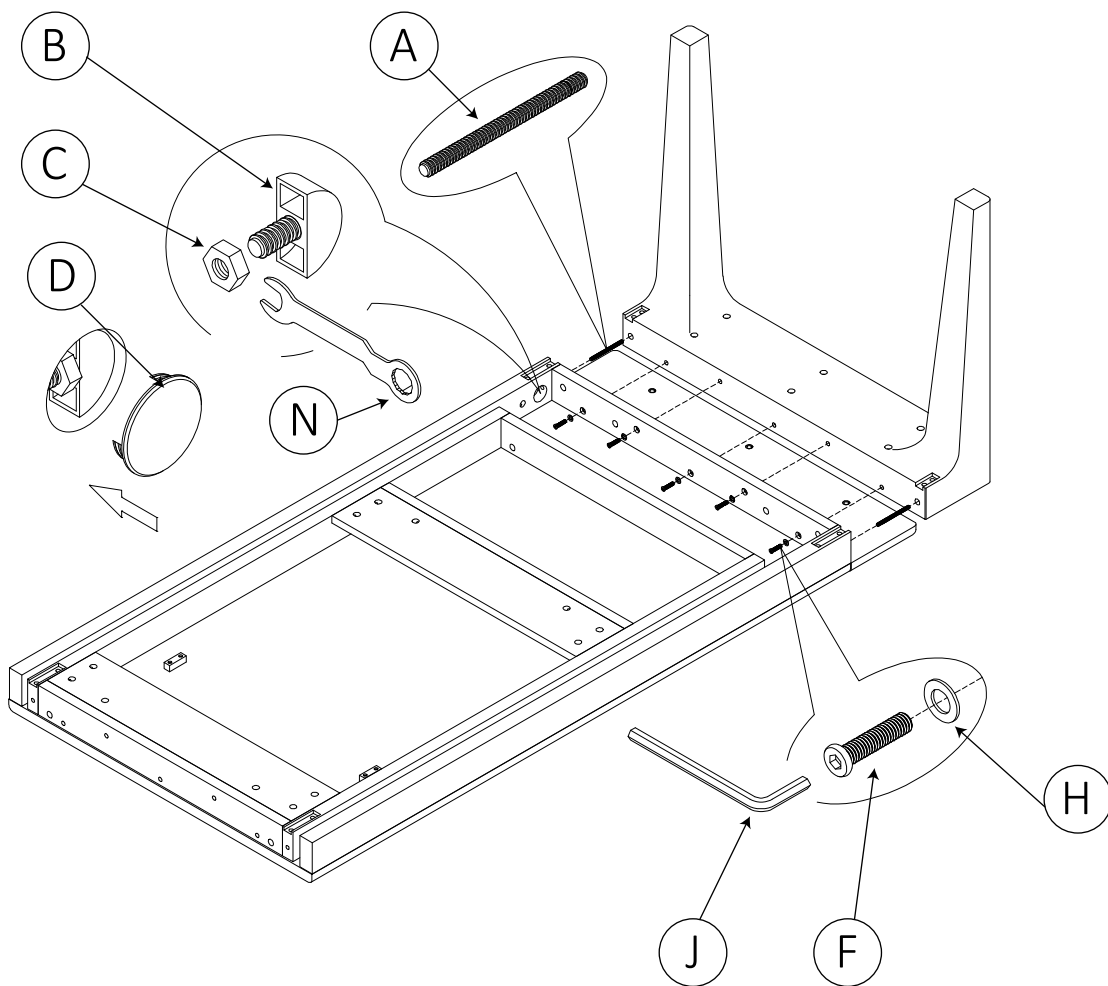















FIG.
1



A	B	C	D	E	F	G
 M8x95	 4 PCS	 M8	 Ø38	 M8x75	 M8x40	 M8x20
4 PCS	4 PCS	4 PCS	4 PCS	6 PCS	10 PCS	16 PCS
H	I	J	K	L	M	N
 Ø14x8.2	 Ø18x8.2	 P5	 38x38			
16 PCS	16 PCS	1 PC	2 PCS	10 PCS	4 PCS	1 PC

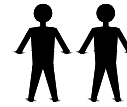
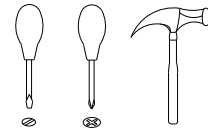
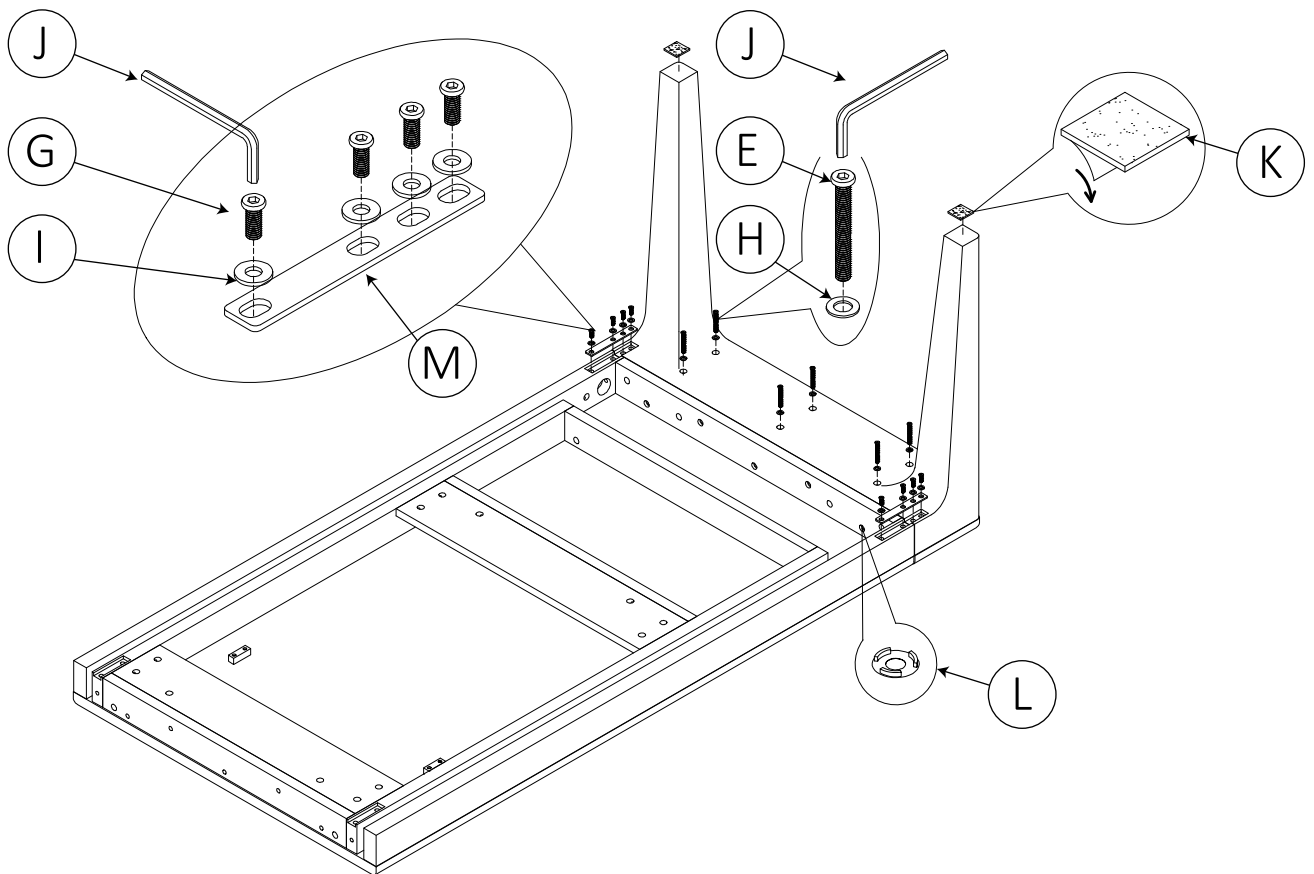















FIG.
2



A	B	C	D	E	F	G
 M8x95		 M8	 Ø38	 M8x75	 M8x40	 M8x20
4 PCS	4 PCS	4 PCS	4 PCS	6 PCS	10 PCS	16 PCS
H	I	J	K	L	M	N
 Ø14x8.2	 Ø18x8.2	 P5	 38x38			
16 PCS	16 PCS	1 PC	2 PCS	10 PCS	4 PCS	1 PC

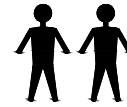
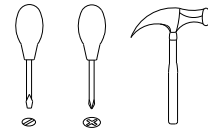
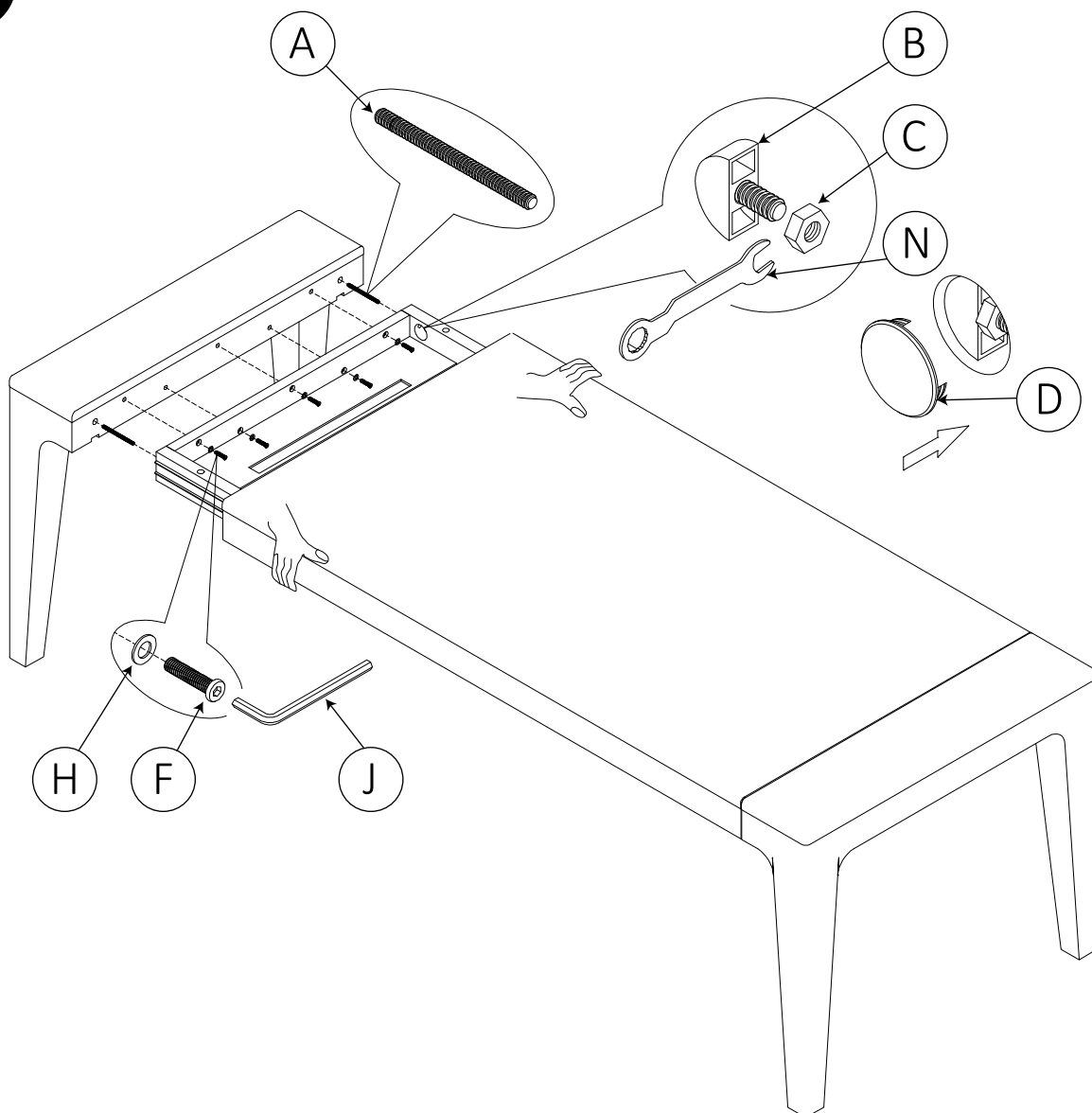















FIG.
3



A	B	C	D	E	F	G
 M8x95	 M8	 M8	 Ø38	 M8x75	 M8x40	 M8x20
4 PCS	4 PCS	4 PCS	4 PCS	6 PCS	10 PCS	16 PCS
H	I	J	K	L	M	N
 Ø14x8.2	 Ø18x8.2	 P5	 38x38			
16 PCS	16 PCS	1 PC	2 PCS	10 PCS	4 PCS	1 PC

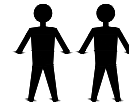
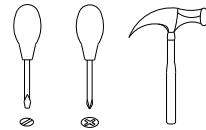
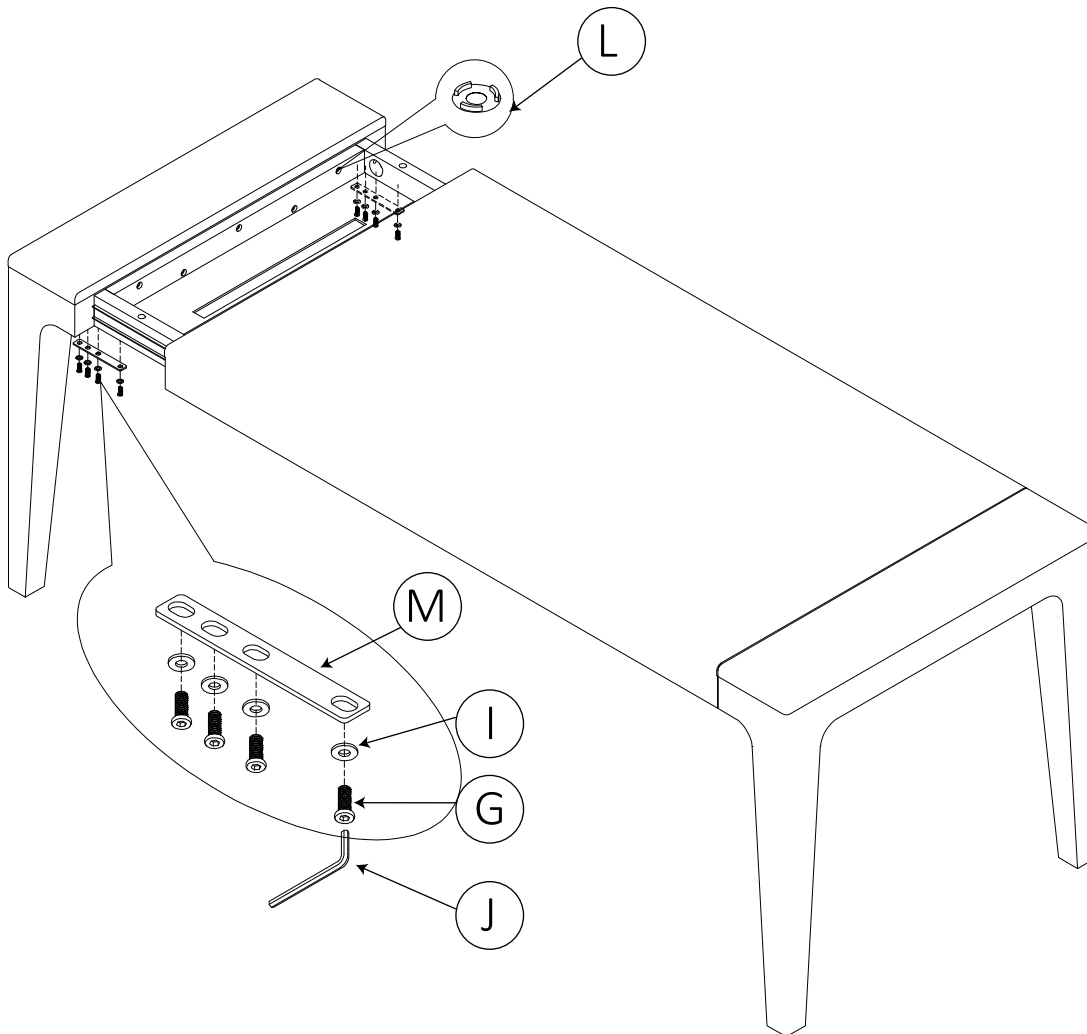















FIG.
4



A	B	C	D	E	F	G
 M8x95		 M8	 Ø38	 M8x75	 M8x40	 M8x20
4 PCS	4 PCS	4 PCS	4 PCS	6 PCS	10 PCS	16 PCS
H	I	J	K	L	M	N
 Ø14x8.2	 Ø18x8.2	 P5	 38x38			
16 PCS	16 PCS	1 PC	2 PCS	10 PCS	4 PCS	1 PC

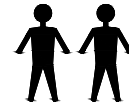
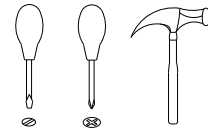

FIG.
5

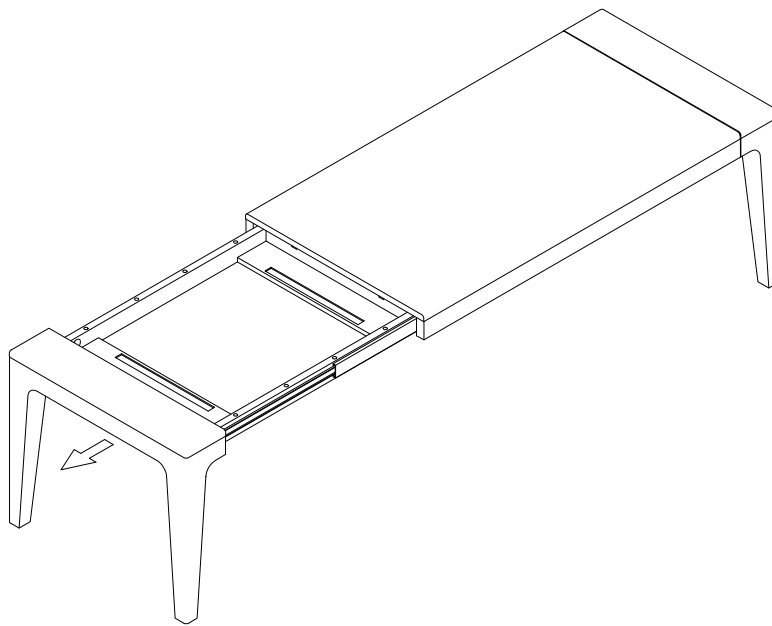

FIG.
6

